



COMPLETE OFFICE SOLUTION

www.bywayindia.com | info@bywayindia.com



CONTACT US:- +91-9811051228, +91-9999351946
www.bywayindia.com | info@bywayindia.com



BYWAY INDIA

Office Furniture

P A R T I T I O N



45 mm

60 mm

75 mm

DESKING



45 mm partition

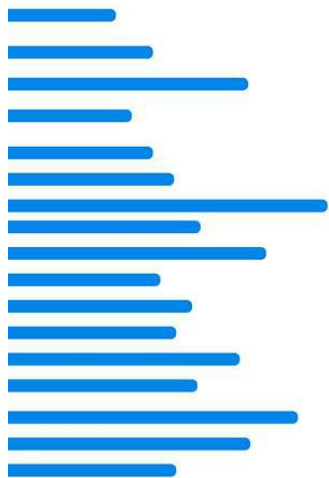

60 mm partition



75 mm partition

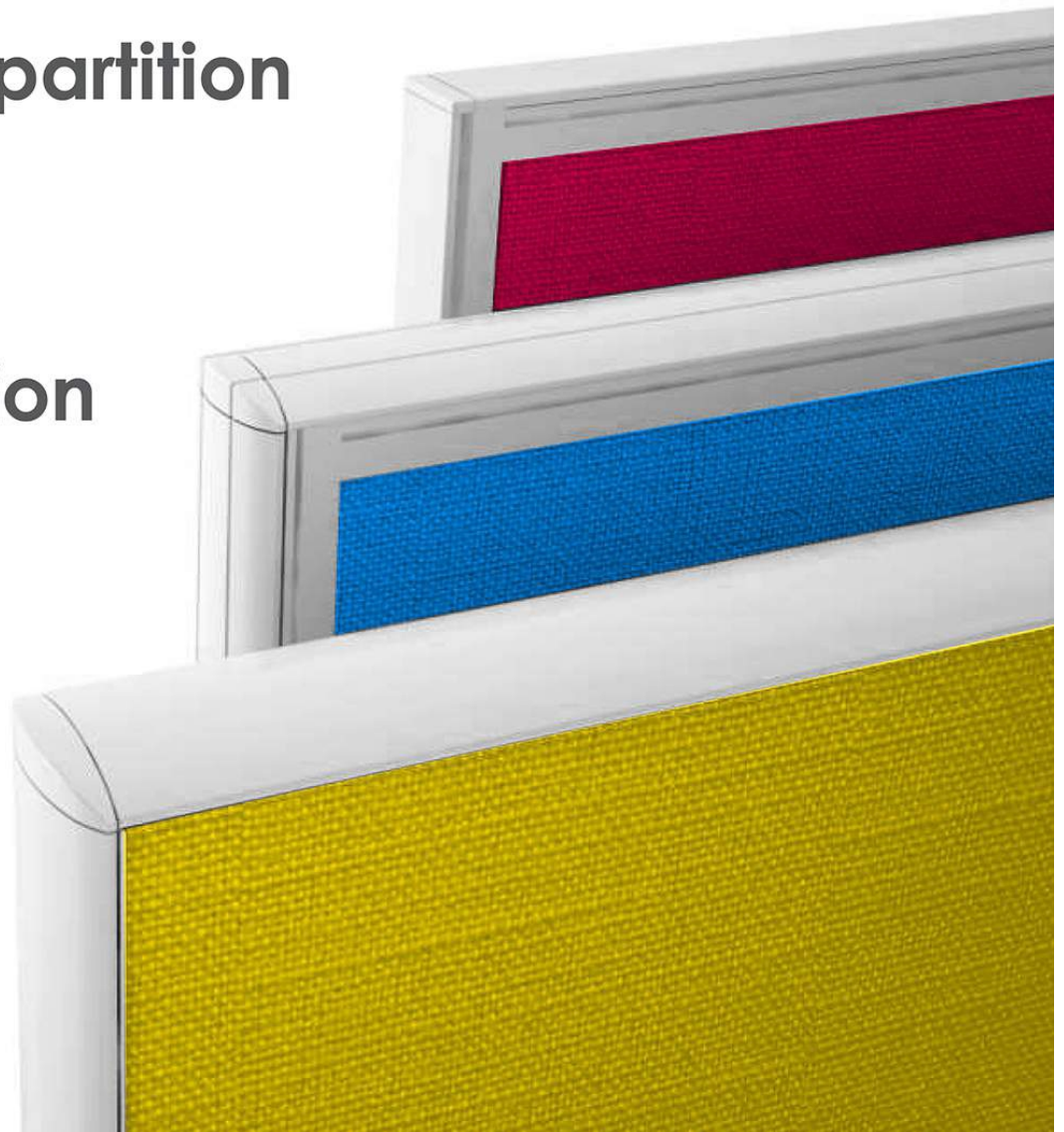

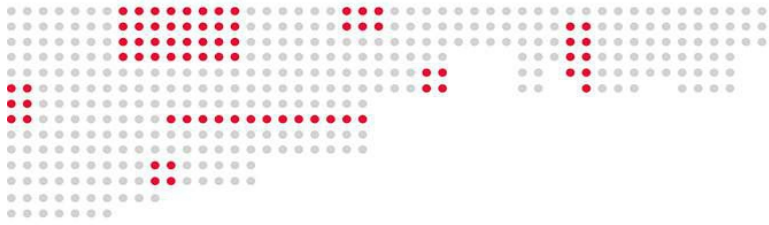

Plus-Type workstation

The ubiquitous workstation, we see in all corporate offices. The table top is L shaped with a curved or deep cut corner curvature. Computer friendly. Wires can either be carried at above table top or below table top level. The table top shape gives ample space for keeping papers and files. Under table storage units are optional. Provisions for pin-up board and marker board have been provided in the partition.

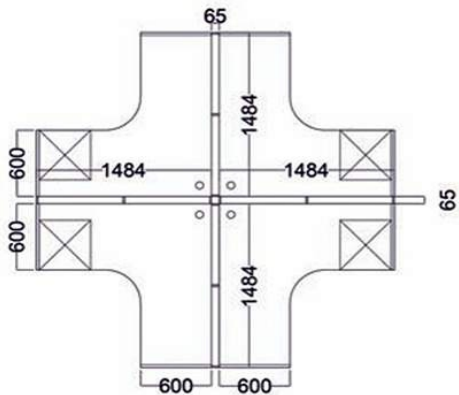

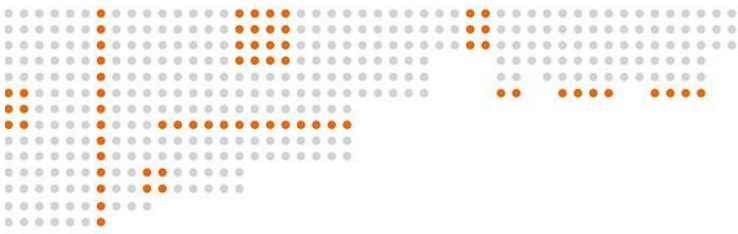

T-Type workstation

The common workstation known as the L shaped table. The workstations are good for corporate houses, software development parks and government offices. Pin-up and marker tiles are provided on the partition wherever required. Electrical and data points can be provided at any level in this system.

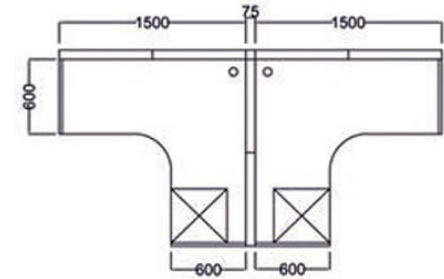

L-Type workstation

We manufacture and provide work stations for our corporate client. Our workstations are designed and fabricated using qualitative raw material.

BYWAY INDIA



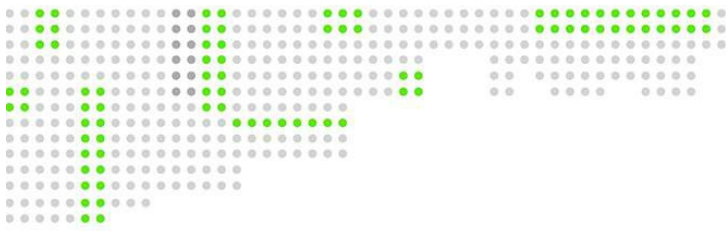

U-Type workstation

We manufacture and provide work stations for our corporate client. Our workstations are designed and fabricated using qualitative raw material.



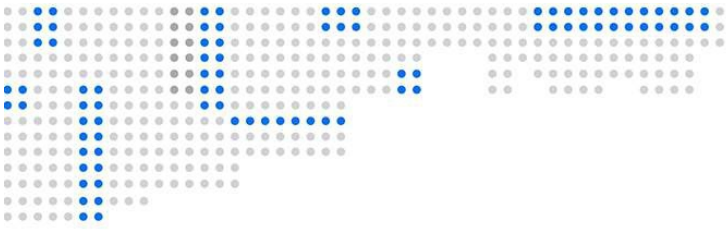

U-Type 2 Sided workstation

We manufacture and provide work stations for our corporate client. Our workstations are designed and fabricated using qualitative raw material.





120 degree-Type workstation

We manufacture and provide work stations for our corporate client. Our workstations are designed and fabricated using qualitative raw material.

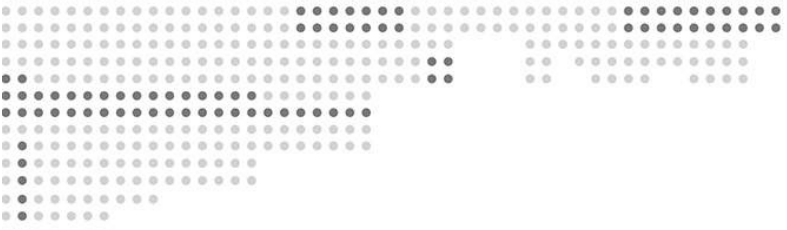

Linear-Type workstation

We manufacture and provide work stations for our corporate client. Our workstations are designed and fabricated using qualitative raw material.

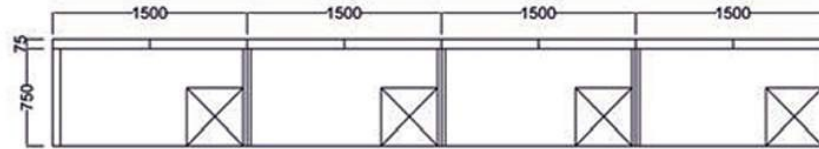

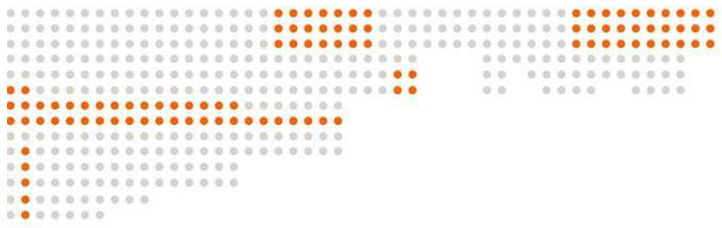

Desking System

We manufacture and provide work stations for our corporate client. Our workstations are designed and fabricated using qualitative raw material.



2-Sided Linear Workstations

We manufacture and provide work stations for our corporate client. Our workstations are designed and fabricated using qualitative raw material.

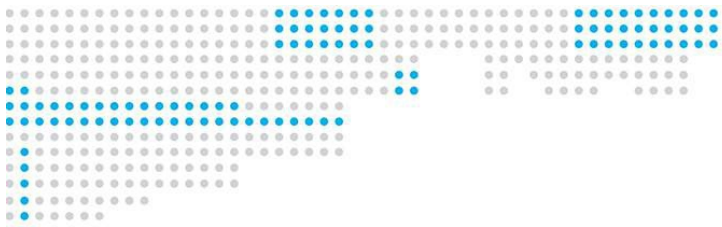

Desking System

We manufacture and provide work stations for our corporate client. Our workstations are designed and fabricated using qualitative raw material.



Linear Workstations

We manufacture and provide work stations for our corporate client. Our workstations are designed and fabricated using qualitative raw material.

Desking System

We manufacture and provide work stations for our corporate client. Our workstations are designed and fabricated using qualitative raw material.

We manufacture and provide work stations for our corporate client. Our workstations are designed and fabricated using qualitative raw material.

U-Type Workstations



120 degree Workstations



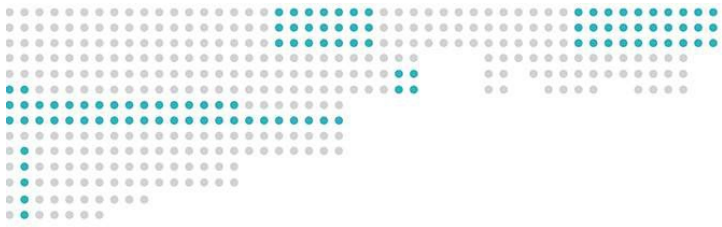

Desking System

We manufacture and provide work stations for our corporate client. Our workstations are designed and fabricated using qualitative raw material.

Linear Workstations

We manufacture and provide work stations for our corporate client. Our workstations are designed and fabricated using qualitative raw material.

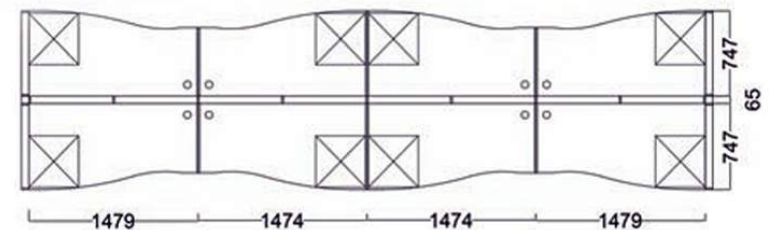

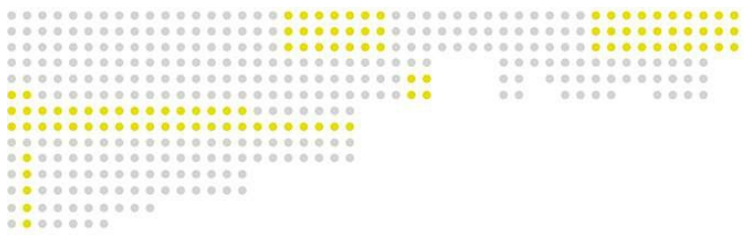

Cabin Table

We manufacture and provide work stations for our corporate client. Our workstations are designed and fabricated using qualitative raw material.



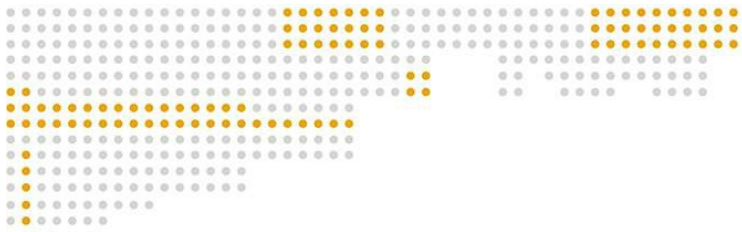

Cabin Table

We manufacture and provide work stations for our corporate client. Our workstations are designed and fabricated using qualitative raw material.



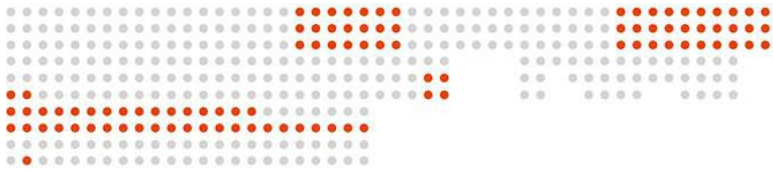

Meeting/Conference Table

We manufacture and provide work stations for our corporate client. Our workstations are designed and fabricated using qualitative raw material.



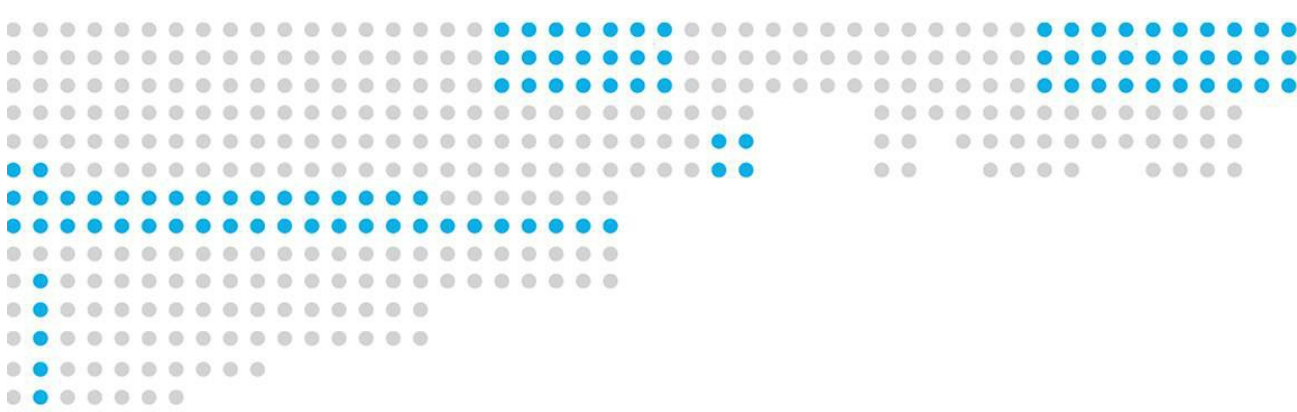

Leg Options...

We manufacture and provide work stations for our corporate client. Our workstations are designed and fabricated using qualitative raw material.

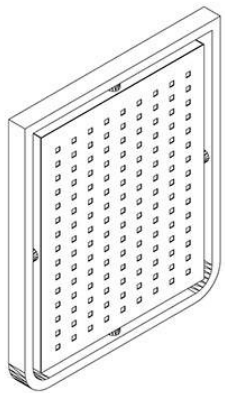

Type A

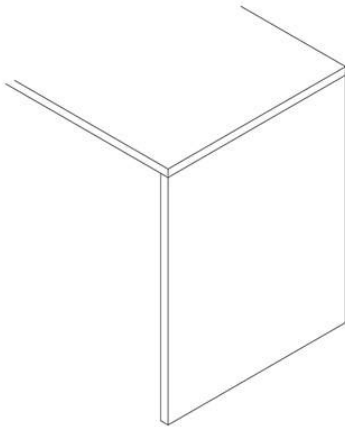

Type B

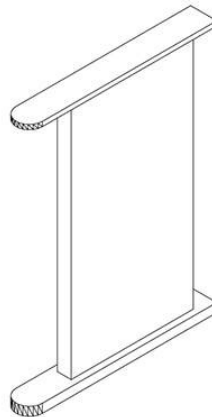

Type C



Type D

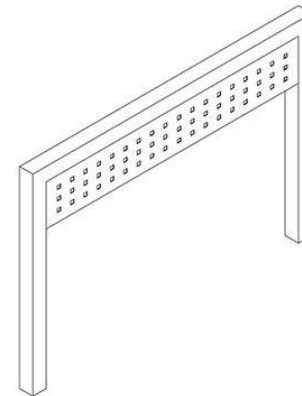

Type E

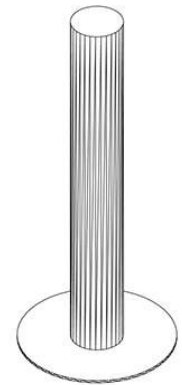

Type F

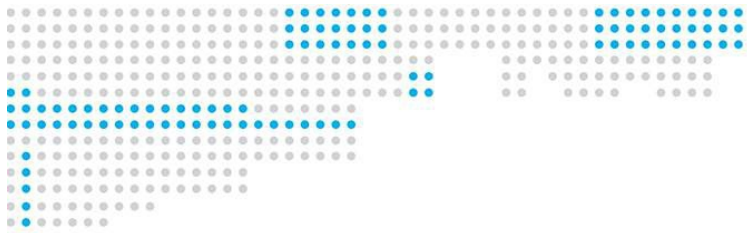

Color/Shade Available

Laminate



Frosty White



Silver Grey



Slate Grey



Intall Beech



Baverian Beech



Mangfall Beech



Highland Pine



Douglas Pine



Oxford Cherry



Sapelli



Wenge



Asian Maple

Powder Coating



Broken White
S/M



White Texture



Ivory Texture



Bone Grey
Structure



Munsal Grey
Structure



Moon Light
Grey



Silver Ash Grey



Graphite Grey
Texture



Black Texture

Fabric

As per standard fabric shade card.



BYWAYINDIA



Plot No- G-154 Sector 63 Noida 201301

+91-9999351946 +91-9811051228

info@bywayindia.com www.bywayindia.com